

REV.	ECR	DESCRIPTION	DATE
-	11128	INITIAL DRAWING REQUEST	4/17/13
A	16330	ADDED REV:001 FUNCTIONALITY	12/26/2018

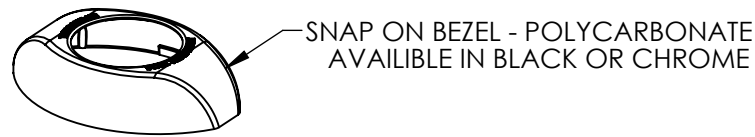

SNAP ON BEZEL - POLYCARBONATE
AVAILABLE IN BLACK OR CHROME

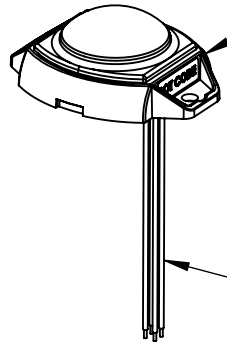

SPHERICAL LED HEAD POLYCARBONATE
w/DIFFUSING OPTICS

ELECTRICAL FUNCTIONS

RED 22 GA 12-24vdc (+ POSITIVE)
BLACK 22 GA GROUND (- NEGATIVE)
GREEN 22 GA PATTERN SELECT (GROUND)
STEADY BURN (+ POSITIVE) REV:001 ONLY $\triangle A$
WHITE 22 GA SYNC WITH OTHER LIGHTS (6 MAX)
AMP DRAW: 1.2 MAX

WIRE LENGTH 7.0"

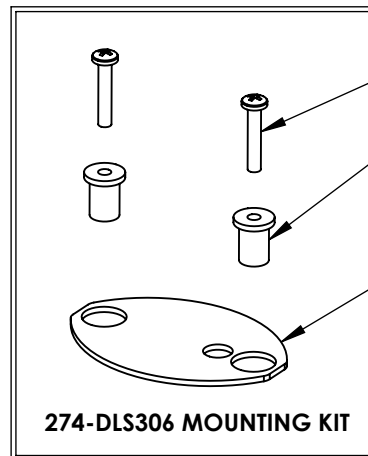
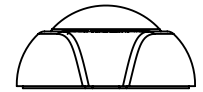
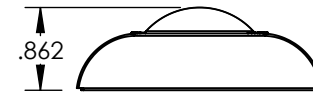
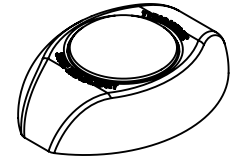
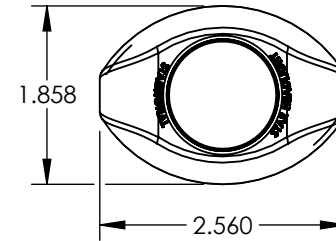

#6-32 x 3/4" SCREWS FOR WELL NUTS

#6-32 WELL NUTS
REQ'S 5/16" DRILLED HOLE

GASKET

274-DLS306 MOUNTING KIT

! NOTE !

Whenever possible mount on metal surface
for best heat sinking.

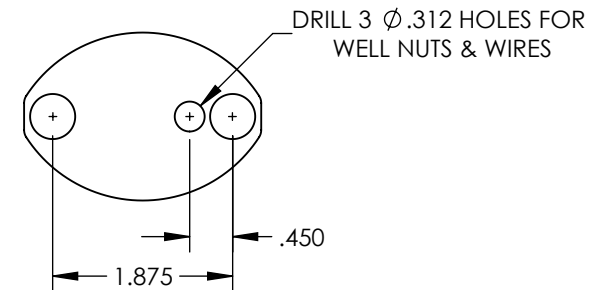

DRILL 3 ϕ .312 HOLES FOR
WELL NUTS & WIRES

MODEL/COLORS
DLS306-AA AMBER/AMBER
DLS306-AB AMBER/BLUE
DLS306-AR AMBER/RED
DLS306-AW AMBER/WHITE
DLS306-BB BLUE/BLUE
DLS306-BW BLUE/WHITE
DLS306-GG GREEN/GREEN
DLS306-RB RED/BLUE
DLS306-RR RED/RED
DLS306-RW RED/WHITE
DLS306-WW WHITE/WHITE

MODELS w/CHROME BEZEL
DLS306C-AA AMBER/AMBER
DLS306C-AB AMBER/BLUE
DLS306C-AR AMBER/RED
DLS306C-AW AMBER/WHITE
DLS306C-BB BLUE/BLUE
DLS306C-BW BLUE/WHITE
DLS306C-GG GREEN/GREEN
DLS306C-RB RED/BLUE
DLS306C-RR RED/RED
DLS306C-RW RED/WHITE
DLS306C-WW WHITE/WHITE

UNLESS OTHERWISE SPECIFIED

DIMENSIONS ARE IN INCHES

TOLERANCES:

ANGULAR: ± 2 DEG.

.X $\pm .100$
.XX $\pm .020$
.XXX $\pm .005$
.XXXX $\pm .001$

RoHS COMPLIANT: NO

MATERIAL:

N/A

FINISH:

NA

DRAWN BY: SWN

DRAWING APPROVED BY ECR

THE INFORMATION CONTAINED IN THIS
DRAWING IS THE SOLE PROPERTY OF
STAR HEADLIGHT & LANTERN CO., INC..
ANY REPRODUCTION IN PART OR AS A
WHOLE WITHOUT THE WRITTEN PERMISSION
OF STAR HEADLIGHT & LANTERN CO., INC.
IS STRICTLY PROHIBITED.

STAR HEADLIGHT & LANTERN CO., INC.

455 Rochester St. Avon NY 14414
Ph:(585) 226-9500 Fax: (585) 226-2029

MODEL: DLS306

TITLE:
DLS306 MODEL DRAWING

DWG. NO.

DLS306

REV

A

SCALE: 1:1

DO NOT SCALE FROM DRAWING

SHEET 1 OF 1